

Lithium Power Supply

User Manual

LPS 1200W-60Ah

LPS 1500W-100Ah

LPS 2500W-100Ah



Compact lithium battery based power supply
- for easy access to 230V and 12V energy, everywhere!

Safety Instructions

The Lithium Power Supply (LPS) is classified as Class 9 hazardous material UN3480, a power source with high energy density and dangerous materials in a closed metal case!

Installation must strictly follow the national safety regulations in compliance with the enclosure, installation, creepage, clearance, casualty, markings, and segregation requirements of the end-use application. Installation must be performed by professional installers only. Switch off the system and check for hazardous voltages before altering any connection!

The Lithium Power Supply must be handled only by qualified and trained personnel.

The lowest protection degree of specific parts of the LPS is in accordance with IP21 requirements.

This is a Class I product. Only connect 230VAC In from a source that is connected to electrical earth, including any extension cords between the source and the unit.

Especially keep these rules:

- Do not open the Lithium Power Supply.
- Do not discharge a new Lithium Power Supply before it has been fully charged first.
- Charge only within the specified limits.
- Do not mount the Lithium Power Supply upside down or on the sides.
- Check if the Lithium Power Supply has been damaged during transport.
- Do not put Lithium Power Supplies in serial or parallel.

Dangers involved in case of fire:

- Danger of dust particle explosions
- Decomposition through fire or heat under development of toxic and cauterizing gases
- Combustion gasses which strongly irritate eyes and respiratory organs

General actions to be taken by the driver if these dangers occur:

- Turn off the engine
- Put a warning signal on the road to warn others
- Inform others about the danger and direct them to stand away from the wind direction
- Call the police and fire department immediately and inform that lithium batteries (UN3480) are on board

Instruction for fire extinguishing:

- Extinguish with water, if possible cover lithium power supply completely in water
- Extinguishing with water will produce fluoride, phosphate, fluoride-oxide and carbon oxide.
- Alternatively extinguish with a CO2 extinguisher.

Note: The LPS must be fully charged before storing and recharged every 6 month.

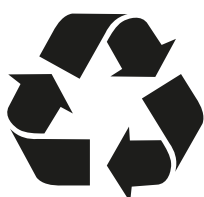

**NON-SPILLABLE
LI-ION BATTERY**



Table of content

Safety instructions.....	2
General information.....	4
Transport	4
Disposal.....	4
Specifications and additional parameters.....	5
Certifications	6
Safety protections	6
Additional protections	6
Installation / Use of 230VAC Input	7
Data connector details	8
Operations - Power On/Off	8
Icon description.....	9
Menu overview	10
Additional information	11
Warranty	12

General information

When the LPS is not used for longer periods of time it must be stored fully charged and **recharged every 6 months**.

ATTENTION: Read the safety instructions before installing the Lithium Power Supply.

ATTENTION: When installing the lithium Power Supply, do not mount it upside down or on the sides. Do not cover or block the fan or the air inlet to insure the battery does not overheat.

Mounting holes are for pre-fixation, suitable fixation has to be added.

ATTENTION: Do not connect the Lithium Power Supply in series or parallel.

ATTENTION: Make sure the Lithium Power Supply is powered down before starting the installation
The LPS is designed for indoor, household and industrial use.

Transport

The Lithium Power Supply is classified as Class 9 hazardous material UN3480 and tested according to UN 38.3. Transport of the Lithium Power Supply must always be in original certified packaging.

The transport of Lithium Power Supply must only be handled by trained people in accordance with ADR, RID and IMDG. For transport by air (IATA) the packaging has to be in accordance with P965, here the original packaging complies.

For shipment of defect batteries, contact your retailer for further information.

Disposal

Batteries marked with the recycling symbol must be processed via a recognized recycling agency. By agreement, they may be returned to the manufacturer. Batteries must not be mixed with domestic or industrial waste.

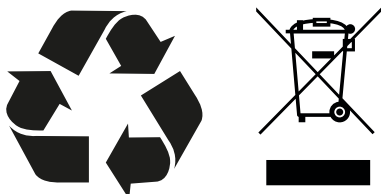

**NON-SPILLABLE
LI-ION BATTERY**

Specifications and additional parameters

Lithium Power Supply (LPS)	LPS 1200W-60Ah	LPS 1500W-100Ah	LPS 2500W-100Ah
Model no.	014-02001GF	014-01004GF	014-03001GF
Battery type	Li-Ion 12V – 60Ah	Li-Ion 12V – 100Ah	Li-Ion 12V – 100Ah
Battery chemistry	LiFePO4	LiFePO4	LiFePO4
Battery capacity	60Ah (792Wh)	100Ah (1320Wh)	100Ah (1320Wh)
Available capacity	48Ah (634Wh)	80Ah (1050Wh)	80Ah (1050Wh)
AC Input Voltage	207 VAC – 253 VAC	207 VAC – 253 VAC	207 VAC – 253 VAC
AC Input frequency	45 Hz – 65 Hz	45 Hz – 65 Hz	45 Hz – 65 Hz
AC Input power	500 W (2,5A)	800 W (3,5A)	800 W (3,5A)
AC Output voltage	230 VAC pure sine wave	230 VAC pure sine wave	230 VAC pure sine wave
AC Output frequency	50 Hz	50 Hz	50 Hz
AC Output power	1000 Wrms (4,5A)	1300 Wrms (6A)	2000 Wrms (8,5A)
AC Output power	15 min / 15 min / 10 min	1500 Wrms (6,5A)	2500 Wrms 11A)
AC Output power	Peak (10sec)	3000 Wrms	5000 Wrms
AC Output power	AC IN connected	1800W (8A) / Socket	2300W (10A) / Socket
DC Input voltage	12 - 15 VDC	12 - 15 VDC	12 - 15 VDC
DC Input continuous current	< 30 A	< 50 A	< 50 A
DC Output Voltage	13,2 VDC (9,2 - 15 VDC)	13,2 VDC (9,2 - 15 VDC)	13,2 VDC (9,2 - 15 VDC)
DC Output continuous current	60 ADC	60 ADC	60 ADC
DC Output Max Impulse current	20 min	70 A	70 A
1 min	100 A	100 A	100 A
10 Sec	150 A	150 A	150 A
Operating temperature	(Output will be limited below 0°C)	-20°C~50°C	-20°C~50°C
Cooling	Forced air (fan)	Forced air (fan)	Forced air (fan)
Self-discharge rate per month	(Sleep mode)	< 3%	< 3%
Operating mode self consumption(Only DC Output active)	5 W	5 W	5 W
Operating mode self consumption(Inverter and DC Output active)	22 W	22 W	35 W
Sleep mode consumption	< 25 mW	< 25 mW	< 25 mW
Connection 230VAC	Neutrik and Schuko	Neutrik and Schuko	Neutrik and Schuko
Connection 12VDC	Anderson SB50	Anderson SB50	Anderson SB50
IP rating	IP21	IP21	IP21
Product weight	26 kg	28 kg	28 kg
Product dimensions in mm	(HxWxL)	250x244x390	250x244x390
Package weight	28 kg	30 kg	30 kg
Package dimensions in mm	(HxWxL)	350 x 355 x 495	350 x 355 x 495

Certifications

Low Voltage Directive 2014/35/EU

EN62368-1:2014

EMC 2014/30/EU

EN61000-6-2:2005, EN61000-6-3:2007 /
A1:2011 EN50498:2010 (UNECE Regulation 10)

RoHs Directive 2011/55/EU

EN50581:2012

Safety protections

- 230vac Input protected by 10AT fuse (not replaceable)
- 230vac Output Protected by 2 x 8A fuse (resetable)
- DC Input Protected by 3 x 40A ATO fuses (replaceable)
- DC Output Protected by 3 x 40A ATO fuses (replaceable)
- Lithium battery protected by fuse (not replaceable)
- L/N relay hazard is hardware protected.
- PE/N relay hazard is hardware protected.

Additional protections

230vac AC Output protections

- Overload
- Short circuit

230vac AC Input protections

- Over / Under voltage
- Frequency
- Controlled charge levels

DC Input

- Over / Under voltage
- Overload
- Controlled charge levels

DC Output

- Overload
- Controlled charge levels
(reverse on output)

Internal Lithium battery protections

- Over charge
- Deep discharge
- Temperature
- Overload

Installation | Use of 230VAC Input

When connecting the LPS to a 230VAC source, the unit will start up and begin to charge the internal battery. Please note that when a 230VAC source is connected the unit will loop the 230VAC directly through to the output sockets, enabling 230VAC out.

Note: Always use a RCD protected source to supply the LPS from 230VAC.

If the 230VAC charge wire is connected to anything else, an RCD must be present immediately after the input socket.

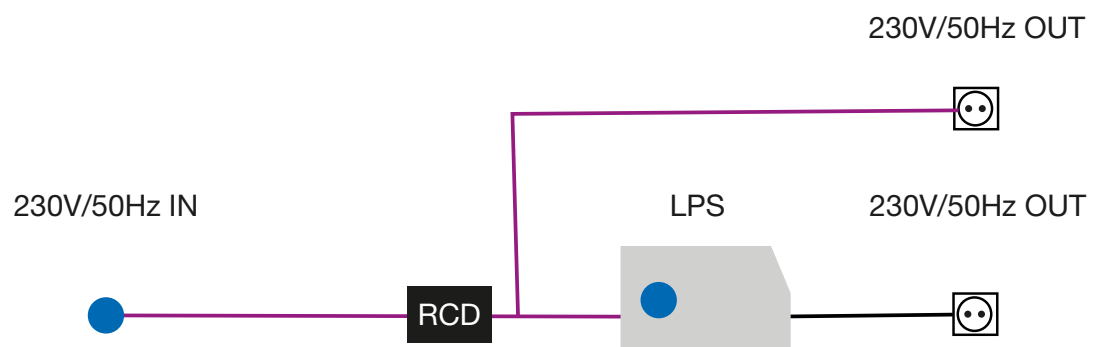

Data connector details



The data connector pins are numbered according to figure 13. The following table shows all pin details on the data connector.

Connector	Pin Signal name	Description
1	Single Wire	Data connection
2	CAN Low	For firmware update
3	GND	Ground connection for accesories
4	GND/+12V	HW 2.01 and below = Ground connection HW 2.02 and above = +12V , 500 mA
5	Input 2	Activation of 230VAC inverter
6	Output 1	For jumpstart
7	CAN high	For firmware update
8	Output 2	Is active when battery capacity is below 10%
9	Input 1	Activates DC charging after 10 seconds

Operations - Power On/Off

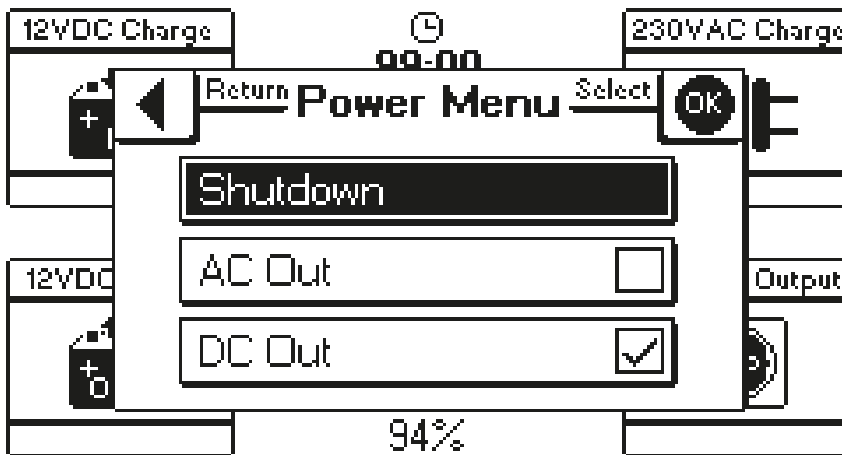
To turn the unit on press the power button . The following menu will show.



To turn on both 230VAC and 12VDC output press . If only 230VAC or 12VDC is needed select either “AC Out” or “DC Out” and press . The power menu for choosing 230VAC and/or 12VDC can always be accessed by pressing the power button .

To turn off the unit press the power button  and select either “Shutdown” or the indicators in both “AC Out” and “DC Out”.

Icon description

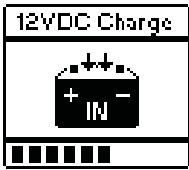

12VDC Input

- Shows the status of the 12VDC Input module.
- The power bar shows the level of total 12VDC charge current.

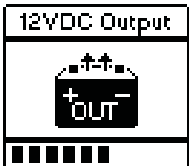

12VDC Output

- Shows the status of the 12VDC Output module.
- The power bar shows the level of total discharge current.
- A flashing power bar indicates an overload

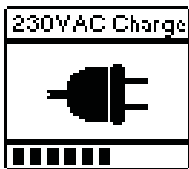

230VAC Input

- Shows the status of the 230VAC Input module.
- The power bar shows the level of total 230VAC charge power.

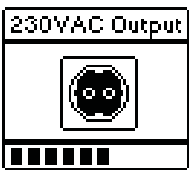

230VAC Output

- Shows the status of the 230VAC Output module.
- The power bar shows the level of total 230VAC output power.
- A blinking power bar indicates an overload

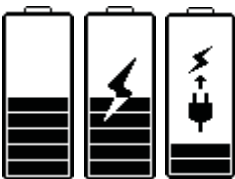

Battery

- Shows the current battery capacity in 10% steps.
- When the battery is charging, a power symbol is shown.
- When the battery is almost empty a connector sign will show.

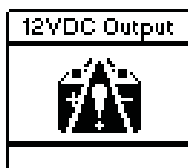

Warning

- If there is an error or warning - a warning sign will appear.

Power flow



- Indicates the direction of power flow.

Module on



- Module is on but with no load / consumption (standby).

Menu overview

- Home screen
- Menu
 - o 230VAC Output
 - Energy Saver (No load)
 - Energy Saver (Threshold)
 - o 230VAC Charge
 - Maximum Current
 - o 12VDC Output
 - Jumpstart
 - Shutdown Delay
 - o 12VDC Charge
 - o General
 - Battery Status
 - Temperature
 - Error Codes
 - About

Additional information

Battery Management System

The LPS has a built-in Battery Management System ensuring full control and safety. The BMS monitors lithium cell activity and uses the information for safety, maintenance, SOC, and interface control.

Charger Control

It is necessary to control the charging of lithium batteries in order to avoid uncontrolled disconnections and to protect the lithium cells from unstable conditions. The integrated Battery Management System always ensures the lithium cells are operated within their safe operating parameters.

Cell voltage measurement

The LPS measures cell voltage with high accuracy. The accuracy is necessary to calculate the SOC as only a few 1/1000 of a volt makes a difference.

Cell temperature measurement

The LPS measures the temperature of all individual cells to ensure that none of the cells overheat or cause thermal runaway. The temperature information is also used for SOC calculations.

Shunt and current measurement

The current passes through an integrated shunt resistor so the LPS can measure the current to and from the cells and use it for protection and SOC calculation.

Integrated safety breaker

The most important part of the LPS circuit protection is the integrated safety breaker. It allows the LPS to cut off all charge and discharge currents in potentially hazardous situations.

Overload protection

The advantage of the internal safety breaker is its capability to disconnect high currents without damaging the main switch. The LPS can use the safety breaker for overload protection without damaging the cells.

Short-circuit protection

The LPS is protected against short circuits by fuses on the inputs and outputs. The 230VAC output furthermore has a built-in RCD to protect the user.

Cell balancing

The advanced SOC calculation ensures that all cells are kept in a balanced condition at all times. The BMS has a high cell-balance current that reduces the need for active cell balancing and restores the cells to a balanced condition faster. The BMS is cell balancing each single cell in charge, discharge and idle mode.

Interface

Each LPS has a service interface that allows a qualified technician to analyse any failures and the general condition of the LPS. The service port also allows for firmware updates.

Power conservation

When the LPS is not in use it will enter a low power state. In this state the LPS keeps power consumption very low to avoid unnecessary discharge of the battery. The LPS can be reactivated through the power switch or by applying a charge source to either the 230VAC input or the 12VDC input.

Warranty

CAUTION & WARNING:

DO NOT USE OR ATTEMPT TO USE THIS PRODUCT UNTIL YOU HAVE READ THIS USER'S MANUAL IN ITS ENTIRETY. IMPROPER INSTALLATION OR USAGE OF THIS DEVICE MAY BE HAZARDOUS AND MAY CAUSE DAMAGE TO OTHER ELECTRICAL EQUIPMENT AND WILL VOID WARRANTY.

Clayton Power warrants, to the original purchaser only, for a period of 24 months from the date of purchase, that the Clayton Power device will be in good working order when properly installed and operated as described in this manual.

If the device fails within this time period under normal use, Clayton Power will, without charge, at the place of Clayton Power's choosing, repair or replace the device - with new or reconditioned parts or a new or reconditioned device as Clayton Power deems necessary.

This warranty is not valid in cases of:

Usage against the recommendations of this manual.

Usage in applications outside of general automotive, solar, industrial or marine applications without the agreement of Clayton Power.

Device modification or repair without written authorization from Clayton Power.

Reverse polarity, excessive overloading, general abuse, neglect, wear & tear, ingress of liquids (water, oil, acid, or otherwise), foreign objects, lightning strikes, over or under voltage, RFI/EMI, etc.

Obtaining Warranty Service

To obtain warranty service, please contact the outlet at which you purchased your product. Do not contact Clayton Power directly. For warranty service provide the following:

- Proof of purchase
- The unit model number
- The unit serial number
- A brief description of the application and problem including any failure codes displayed on the unit.
- Contact your Clayton Power dealer for an authorization number prior to dispatch - do not send without authorization.
Once this number has been obtained, please carefully pack your unit and send (freight paid) to the Clayton Power dealer.
- Please note that the unit contains Lithium batteries and must be shipped as dangerous goods according to UN3480 Lithium-Ion Batteries.

Copyright

The information contained within this document remains the sole property of Clayton Power. No part of this document may be copied or reproduced in any form or by any means, and the information contained within is not to be communicated to third parties, without the prior written consent of Clayton Power.